

# Pitch:2.54mm (0.1")

## Single Row Pin Header S.M.T Type

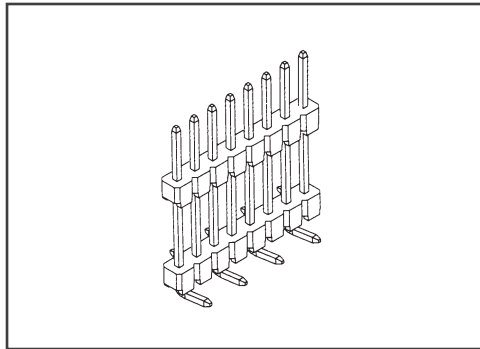

### SPECIFICATIONS

Current Rating: 3 Amps  
 Insulator resistance:1000 Megohms Min.  
 Dielectric withstanding:AC 500 V  
 Contact Resistance:20 Megohms Max  
 Operating Temperature:-40° C - +105° C

### MATERIALS

Contact Material:Brass  
 Insulator Material:30% Glass filled  
 P. B. T UL94V-0  
 Finish:Gold /Tin Plated over nickel

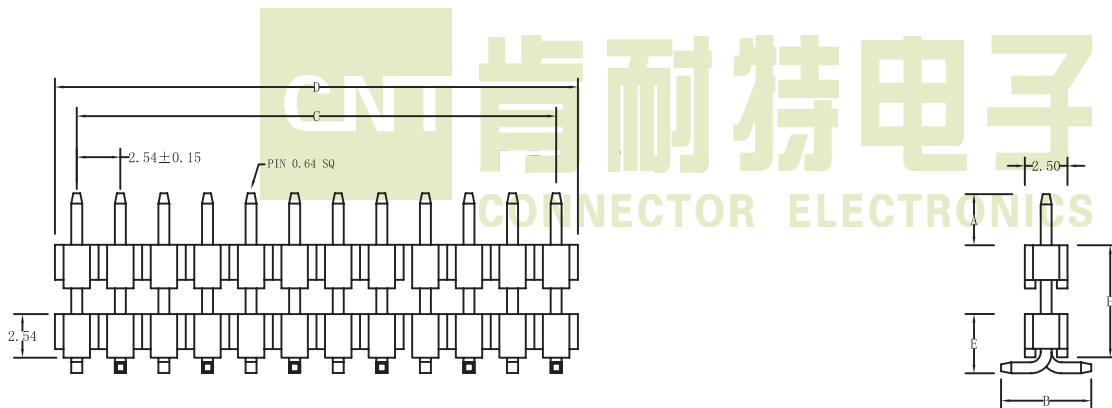
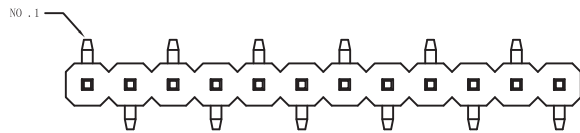

### Recommended P. C. Board Hole Layout

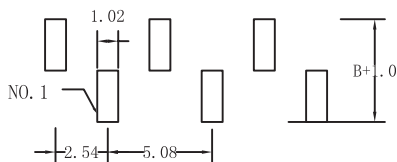

No. of Pins Per Row		02~40
Dimension		
C	2.54*No.of Contacts-2.54	±0.25
D	2.54*No.of Contacts	±0.38

### Ordering Information

**M 254 1 \* XX G M2 A/H/B/E**  
 M: Pitch: 1: No. of pins per Row G: GoldPlated M: S.M.T Type 2 A/H/B/E: Custom Length Available  
 Male 2.54mm Single Row T: Tin Plated